

MORTISE CYLINDERS – KEYING KIT



FOR 700 SERIES CYLINDERS (FOR KA - KA GROUPS - MK SYSTEMS)

FOR 900 SERIES CYLINDERS (FOR KA - KA GROUPS - MK SYSTEMS)

ITEM No.	Description	Wt. g
3983	Keying kit for 700 series cylinders	2500

ITEM No.	Component description	Ø mm	Length mm	Pcs.
2.0.3982.828.50.000	Rounded brass pins	2,8	5,00	500
2.0.3982.828.54.000	Rounded brass pins	2,8	5,40	500
2.0.3982.828.58.000	Rounded brass pins	2,8	5,80	500
2.0.3982.828.62.000	Rounded brass pins	2,8	6,20	500
2.0.3982.828.66.000	Rounded brass pins	2,8	6,60	500
2.0.3982.828.70.000	Rounded brass pins	2,8	7,00	500
2.0.3982.828.74.000	Rounded brass pins	2,8	7,40	500
2.0.3982.818.49.000	Flat brass pins (for systems)	2,8	4,90	500
2.0.3982.818.53.000	Flat brass pins (for systems)	2,8	5,30	500
2.0.3982.818.57.000	Flat brass pins (for systems)	2,8	5,70	500
2.0.3982.818.61.000	Flat brass pins (for systems)	2,8	6,10	500
2.0.3982.818.65.000	Flat brass pins (for systems)	2,8	6,50	500
2.0.3982.810.08.000	Wafers	2,8	0,80	500
2.0.3982.810.12.000	Wafers	2,8	1,20	500
2.0.3982.810.16.000	Wafers	2,8	1,60	500
2.0.3982.810.20.000	Wafers	2,8	2,00	500
2.0.3982.810.24.000	Wafers	2,8	2,40	500
2.0.3983.808.00.035	Mushroom brass counterpins	2,8	3,50	200
2.0.3983.808.00.065	Mushroom brass counterpins	2,8	5,50	200
2.0.3983.800.00.013	Springs	2,9	8,00	200
2.0.3983.800.00.014	Springs	2,9	15,20	200
2.0.3983.053.00.702	Plugs	3,3	2,10	500
2.0.3983.053.00.721	Plugs	3,3	4,00	500
2.0.3983.045.00.702	Retaining rings	-	-	200
2.0.3983.045.00.721	Retaining rings	-	-	200

ITEM No.	Description	Wt. g
3984	Keying kit for 900 series cylinders	1530

ITEM. N.	Component description	Ø mm.	Long. mm.	Pce
2.0.3984.828.01.000	Rounded brass pins	2,8	5,05	500
2.0.3984.828.02.000	Rounded brass pins	2,8	5,7	500
2.0.3984.828.03.000	Rounded brass pins	2,8	6,35	500
2.0.3984.828.04.000	Rounded brass pins	2,8	7	500
2.0.3984.828.05.000	Rounded brass pins	2,8	7,65	500
2.0.3984.828.06.000	Rounded brass pins	2,8	8,3	500
2.0.3984.810.01.000	Wafers	2,8	0,5	500
2.0.3984.810.02.000	Wafers	2,8	1,15	500
2.0.3984.810.03.000	Wafers	2,8	1,8	500
2.0.3984.810.04.000	Wafers	2,8	2,45	500
2.0.3984.810.05.000	Wafers	2,8	3,1	500
2.0.3984.808.50.000	Mushroom brass counterpins	2,8	5	200
2.0.3984.804.50.000	Flat brass counterpins	2,8	5	200
2.0.3984.811.00.045	Flat brass UN counterpins	2,8	4,5	200
2.0.3984.811.00.030	Flat brass UN counterpins	2,8	3	200
2.0.3984.800.00.000	Springs	2,7	15,3	200
2.0.3984.800.00.062	UN Spring	2,2	13,5	200
2.0.3983.053.00.702	Caps	3,3	2,1	500
2.0.3983.045.00.702	Retaining rings	-	-	200
2.0.3983.045.00.721	Retaining rings	-	-	200
2.0.3984.045.00.708	Retaining rings	-	-	200

TOOLS	Description	N°
Pliers for retaining rings		N° 570.14033.000

TOOLS	Description	N°
Filling tool for inserting pins from the inside		N° 570.16023.000
FILLING TOOL COMPONENTS:	Base Rod Distribution case	N° 570.12055.000 N° 570.12055.002 N° 570.12055.007
OTHER TOOLS	Tool for body spring and counterpin retaining Pliers for retaining rings	N° 570.14413.000 N° 570.14033.000

FOR 820 SERIES "EURO-PRO" CYLINDERS (FOR KA - KA GROUPS)

ITEM No.	Description	Wt. g
3985	Keying kit for Europro cylinders	860

ITEM No.	Component description	Ø mm	Length mm	Pcs.
2.0.3985.824.01.000	Rounded brass pins	2,4	5,20	500
2.0.3985.824.02.000	Rounded brass pins	2,4	5,70	500
2.0.3985.824.03.000	Rounded brass pins	2,4	6,20	500
2.0.3985.824.04.000	Rounded brass pins	2,4	6,70	500
2.0.3985.824.05.000	Rounded brass pins	2,4	7,20	500
2.0.3985.824.59.000	Rounded brass pins (for system)	2,4	5,90	500
2.0.3985.824.65.000	Rounded brass pins (for system)	2,4	6,55	500
2.0.3985.809.05.000	Wafers	2,4	0,55	500
2.0.3985.809.12.000	Wafers	2,4	1,20	500
2.0.3985.809.18.000	Wafers	2,4	1,85	500
2.0.3985.805.53.000	Mushroom brass counterpins	2,4	5,30	200
2.0.3985.804.53.000	Mushroom brass counterpins	2,4	5,30	200
2.0.3985.800.00.000	Springs	2,3	13,50	200
2.0.3983.045.00.721	Retaining rings	-	-	200
2.0.3985.045.00.875	Retaining rings for item 875.30.10	-	-	200

TOOLS	Description	N°
Filling tool for inserting pins from the inside		N° 570.16024.000
COMPONENTI DELL'ATTREZZO DI RIEMPIMENTO:	Base Rod Distribution case	N° 570.12055.000 N° 570.12055.021 N° 570.12055.020
OTHER TOOLS:	Tool for body spring and counterpin retaining Pliers for retaining rings	N° 570.15973.000 N° 570.14033.000

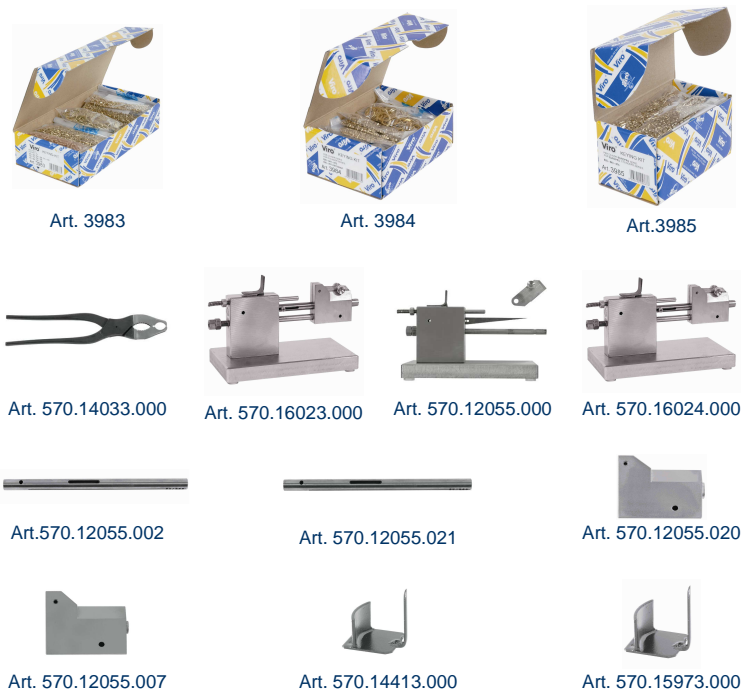

MORTISE CYLINDERS - 700 SERIES



GENERAL STRUCTURAL FEATURES

- The cylinders 700 and 740 range are available in both symmetric and asymmetric version.
 - Body** solid, extruded, pickled brass.
 - Mechanism:** brass pins and counterpins, mushroom brass counterpins, pick-resistant; phosphor bronze pin springs.
 - Keys:** supplied with 3 nickel-plated brass Viro profile keys.
 - Standard:** brass version, universal 0° cam.
 - On request:** nickel plated version and/or DIN 30° cam for ranges 700 and 770; nickel plated version with DIN cam for range 740.
 - Supplied with:** metric-thread fixing screw.
 - All special executions are possible.**
 - Keying kit available, see page 4.**
- Versions available with patented profile keys (form trademark) which can only be duplicated by Viro (.PB profile) or versions which can be duplicated only Viro Authorized Centres (.PV profile).

ITEM No.	Total length mm	Cam position mm	Pins	Keys item	Unit weight	Pcs. per pack
	A	E - I	No.	No.	g	No.
721	54	27 - 27	4	017	190	10
722	60	27 - 33	4	017	210	10
1.722	60	33 - 27	4	017	210	10
727	62	31 - 31	5	015	220	10
722.27.37	64	27 - 37	4	017	225	10
723	66	33 - 33	5	015	230	10
724	70	27 - 43	4	017	240	10
1.724	70	43 - 27	4	017	240	10
751.25	70	30 - 40	4	017	240	10
725	74	37 - 37	5	015	255	10
752.25	75	30 - 45	4	017	255	10
726	80	27 - 53	4	017	275	10
753.30	80	35 - 45	5	015	275	10
753.35	80	40 - 40	5	015	275	10
755.30	90	35 - 55	5	015	300	10
755.35	90	40 - 50	5	015	300	10
755.40	90	45 - 45	5	015	300	10
757.55	100	60 - 40	5	015	340	10
757.60	100	65 - 35	5	015	340	10

700 RANGE - DOUBLE CYLINDERS

- The emergency function allows the cylinder to be opened from the outside even if there is a key inserted on the inside.
- By inverting the inside - outside insertion, the cylinders work like normal cylinder (without the emergency opening function).

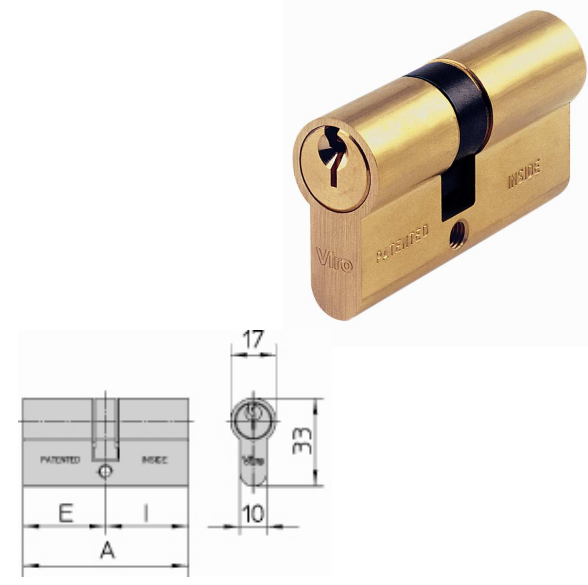

ITEM No.	Total length mm	Cam position mm	Pins	Keys item	Unit weight	Pcs. per pack
	A	B - C	No.	No.	g	No.
740.1	60	30 - 30	5	015	280	10
740.2	65	30 - 35	5	015	290	10
740.3	70	30 - 40	5	015	305	10
740.7	70	35 - 35	5	015	305	10
740.13	80	40 - 40	5	015	335	10

740 RANGE - THUMB TURN CYLINDERS

- Thumb turn cylinders with easy grip.
- They are recommended as alternative to the emergency opening function.

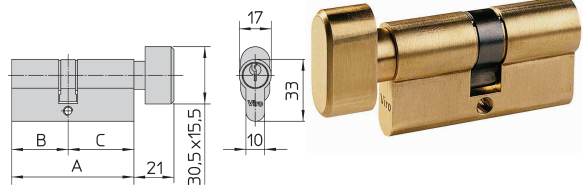

ITEM No.	Total length mm	Cam position mm	Pins	Keys item	Unit weight	Pcs. per pack
	A	B - C	No.	No.	g	No.
771	35	27 - 8	4	017	140	10
1.772	40	30 - 10	5	015	160	10
772	41	33 - 8	5	015	160	10
773	45	37 - 8	5	015	170	10

770 RANGE - HALF CYLINDERS

- Mainly indicated to be combined with electric locks, up and over door locks and automatic door.

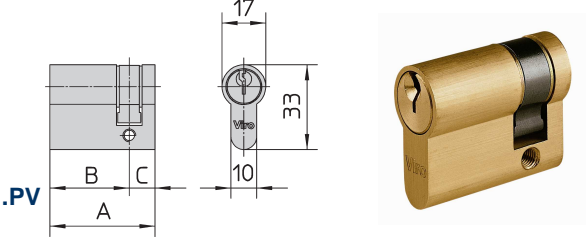

■ For versions with patented profile keys the item code should be followed by: .PB or .PV
 ⚡ Half cylinder specifically recommended for use with the "New Condor" item 1.4218

MORTISE CYLINDERS - 900 SERIES



- The cylinders 920 and 940 range are available both in symmetric and asymmetric version.
- Body:** solid, extruded, pickled brass.
- Mechanism:** brass pins and counterpins, some mushroom-shaped, pick-resistant; phosphor bronze pin springs.
- Keys:** supplied with 3 nickel-plated brass Viro universal profile keys.

- Standard:** brass version with universal 0° cam.
- Supplied with:** metric-thread fixing screw.
- On request:** nickel plated version with DIN 30° cam (add .9 at the end of the item code).
- Standard KA executions are available.**

920 RANGE - DOUBLE CYLINDERS

★ All special executions are available on request for these sizes, for the brass versions with universal cam. Standard KA executions are available for all other sizes.

N.B: A mixed cylinder-padlock system can be created with the sizes marked with the symbol ★ that use the 062 key and the Fai by Viro 50 mm padlock item 1.555

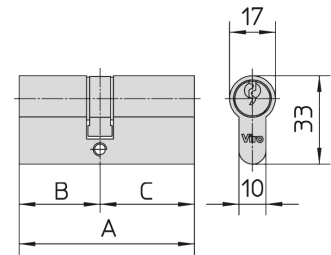

ITEM No.	Total length mm	Cam position mm.	Pins	Keys item	Unit weight	Pcs. per pack
	A	B - C	No.	No.	g	No.
★920.1	54	27 - 27	4	061	195	10
★920.2	60	27 - 33	4	061	210	10
★920.3	60	30 - 30	5	062	210	10
★920.4	65	30 - 35	5	062	225	10
★920.5	70	30 - 40	5	062	225	10
★920.15	70	35 - 35	5	062	225	10
920.6	75	30 - 45	5	062	260	10
920.16	75	35 - 40	5	062	260	10
★920.7	80	30 - 50	5	062	275	10
920.17	80	35 - 45	5	062	275	10
920.25	80	40 - 40	5	062	275	10
920.9	90	30 - 60	5	062	275	10
920.19	90	35 - 55	5	062	275	10
920.32	90	45 - 45	5	062	275	10
920.11	100	30 - 70	5	062	335	10
920.34	100	45 - 55	5	062	335	10
920.35	100	50 - 50	5	062	335	10
920.12	110	30 - 80	5	062	360	10
920.30	110	40 - 70	5	062	360	10
920.13	120	30 - 90	5	062	375	10

ITEM No.	Total length mm	Cam position mm.	Pins	Keys item	Unit weight	Pcs. per pack
	A	B - C	No.	No.	g	No.
941.1	54	27 - 27	4	061	255	10
941.2	60	27 - 33	4	061	275	10
941.3	60	33 - 27	5	062	275	10
★941.4	60	30 - 30	5	062	275	10
★941.26	65	30 - 35	5	062	285	10
941.5	66	33 - 33	5	062	290	10
★941.6	70	30 - 40	5	062	305	10
★941.16	70	35 - 35	5	062	305	10
941.8	75	35 - 40	5	062	305	10
941.9	80	30 - 50	5	062	335	10
941.10	80	35 - 45	5	062	335	10
★941.11	80	40 - 40	5	062	335	10
941.12	90	35 - 55	5	062	365	10

941 RANGE - THUMB TURN CYLINDERS

- Thumb turn cylinders with easy grip.
- They are recommended as alternative to the emergency opening function.

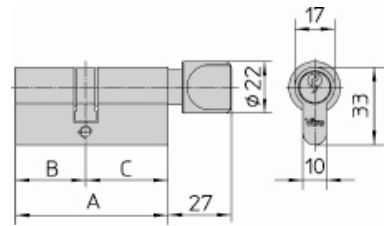

ITEM No.	Total length mm	Cam position mm	Pins	Keys item	Unit weight	Pcs. per pack
	A	B	No.	No.	g	No.
★975.10	35	25	4	061	140	10
★975.1	40	30	5	062	155	10
★975.2	45	35	5	062	170	10
975.3	50	40	5	062	185	10
975.4	55	45	5	062	205	10
975.5	60	50	5	062	220	10

975 RANGE - HALF CYLINDERS

- Mainly indicated to be combined with electric locks, up and over door locks and automatic door gates.

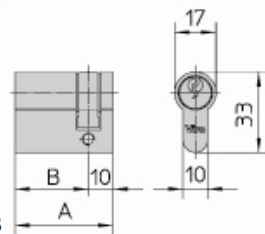

★ Half cylinder specifically recommended for use with the "New Condor" item 1.4218

MORTISE CYLINDERS - 820 SERIES "EURO-PRO"



- Body:** solid extruded brass.
- Mechanism:** brass pins and counterpins, inox stainless steel pin springs. Mushroom counterpins, resistant to attack.
- Keys:** supplied with 5 flat and reversible keys with special "Pearl Nickel" plating, in sealed envelope.

- Ownership card** indicating key code.
- Standard finish:** special "Pearl Nickel" plating (.009), DIN 30° cam.
- Supplied with:** metric-thread fixing screw.
- On request:** polished and lacquered brass (.013).
- Standard KA executions are available.**
- Keying kit available, see page 4.**

820 RANGE - DOUBLE CYLINDERS

ITEM No.	Total length mm	Cam position mm	Pins	Keys item	Unit weight	Pcs. per pack
	A	B - C	No.	No.	g	No.
★820.30.30.009	62	31 - 31	6	063.A	300	5
★820.30.35.009	66	31 - 35	6	063.A	310	5
★820.35.35.009	70	35 - 35	6	063.A	315	5
★820.30.40.009	71	31 - 40	6	063.A	315	5
★820.35.40.009	75	35 - 40	6	063.A	335	5
820.30.45.009	76	31 - 45	6	063.A	335	5
★820.35.45.009	80	35 - 45	6	063.A	355	5
★820.40.40.009	80	40 - 40	6	063.A	355	5
820.30.50.009	81	31 - 50	6	063.A	355	5
820.40.45.009	85	40 - 45	6	063.A	360	5
820.35.55.009	90	35 - 55	6	063.A	380	5
820.45.45.009	90	45 - 45	6	063.A	380	5
820.40.50.009	90	40 - 50	6	063.A	380	5
820.45.55.009	100	45 - 55	6	063.A	410	5
820.50.50.009	100	50 - 50	6	063.A	410	5
820.40.60.009	100	40 - 60	6	063.A	410	5

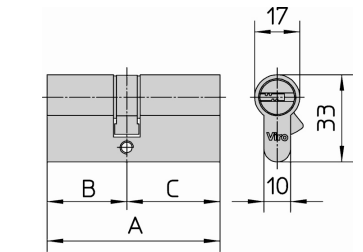

ITEM No.	Total length mm	Cam position mm	Pins	Keys item	Unit weight	Pcs. per pack
	A	B - C	No.	No.	g	No.
★840.30.30.009	62	31 - 31	6	063.A	360	5
840.30.35.009	66	31 - 35	6	063.A	365	5
840.35.30.009	66	35 - 31	6	063.A	365	5
840.35.35.009	70	35 - 35	6	063.A	380	5
840.30.40.009	71	31 - 40	6	063.A	380	5
840.40.30.009	71	40 - 31	6	063.A	380	5
840.45.35.009	80	45 - 35	6	063.A	415	5
840.40.40.009	80	40 - 40	6	063.A	415	5
840.45.45.009	90	45 - 45	6	063.A	440	5

840 RANGE - THUMB TURN CYLINDERS

- Removable knob with easy grip.

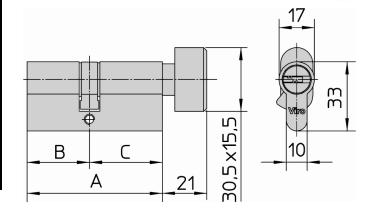

ITEM No.	Total length mm	Cam position mm	Pins	Keys item	Unit weight	Pcs. per pack
	A	B - C	No.	No.	g	No.
★875.30.10.009	40	30	6	063.A	220	5
875.35.10.009	45	35	6	063.A	250	5

875 RANGE - HALF CYLINDERS

- Mainly indicated to be combined with electric locks, up and over door locks and automatic door.

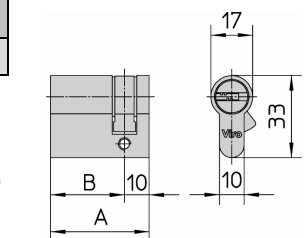

- ★ For these sizes, all special executions will be possible. Standard KA executions only are available for all other size.
- ★ Half cylinder specifically recommended for use with the "New Condor" item 1.4218